

INPOINT III LED

LED INNENLEUCHTE

LED INTERIOR LAMP



aspoeck.com



PRODUCT INFO

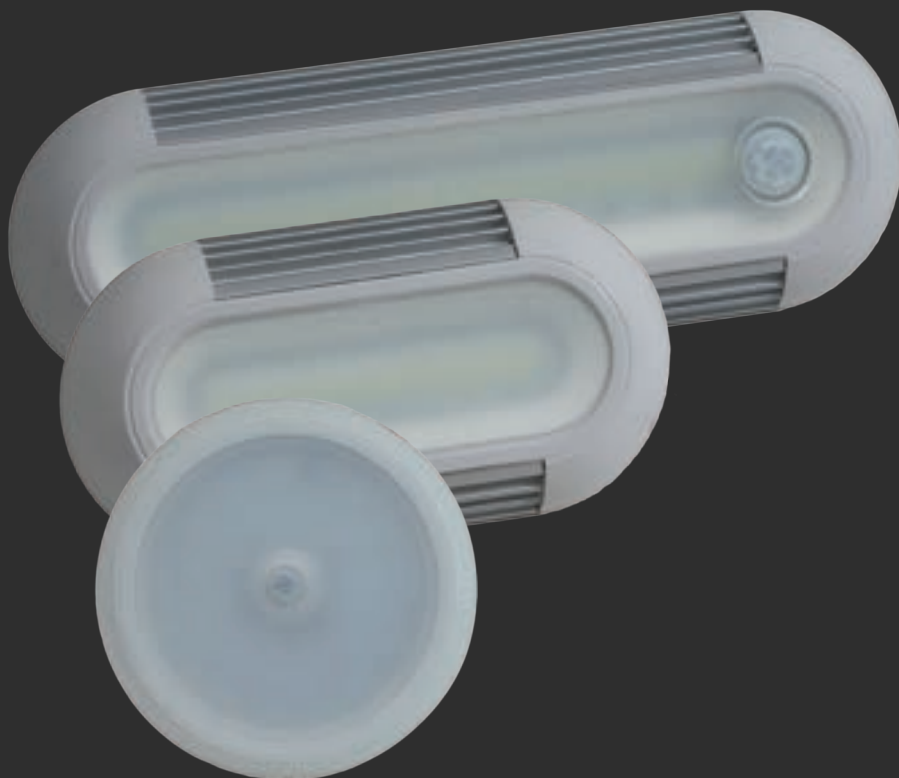



INPOINT III LED

LED INNENLEUCHTE

LED INTERIOR LAMP



FEATURES

LANGE LEBENSDAUER

LONG LIFE CYCLE

6000 KELVIN ALS OPTIMALES ARBEITSLICHT

6000 KELVIN MEANS OPTIMAL WORK LIGHT

HOHE LICHTAUSBEUTE

HIGH LIGHT OUTPUT

GERINGER STROMVERBRAUCH

LOW POWER CONSUMPTION

DREI UNTERSCHIEDLICHE AUSFÜHRUNGEN

THREE DIFFERENT VERSION

VOLL LED

FULL LED

MODERNES AUSSEHEN

MODERN LOOK

DUAL VOLTAGE





[A]



[B]



[C]

TECHNISCHE DATEN TECHNICAL FACTS				
		KURZ/SHORT	LANG/LONG	RUND/ROUND
SPANNUNGSBEREICH: VOLTAGE RANGE:		12/24 V	12/24 V	12/24 V
LUMEN:		300	600	500
LEISTUNG: POWER:		5 Watt	10 Watt	18 Watt
MATERIAL: MATERIAL:		PC, Aluminium	PC, Aluminium	PC, Aluminium
TEMPERATURBEREICH: TEMPERATURE RANGE:		- 40°C~ +80°C	- 40°C~ +80°C	- 40°C~ +80°C
LICHTFARBE: LIGHT COLOUR:		6000 +/- 500k	6000 +/- 500k	6000 +/- 500k
IP-KLASSE: IP-RATING:	OHNE SCHALTER WITHOUT SWITCH	IP6K9K	IP6K9K	IP6K9K
	MIT SCHALTER WITH SWITCH	IP6K9K	IP6K9K	IP6K9K
	MIT BEWEGUNGSSENSOR WITH MOTION SENSOR	IP67	IP67	IP67
EMV-ABNAHME: EMC APPROVAL:		EMC R10	EMC R10	EMC R10

PRODUCT INFO



[A]



[B]





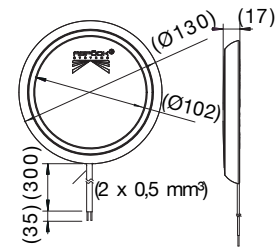
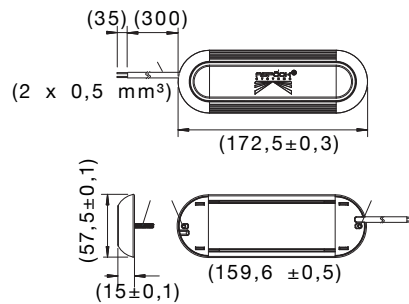
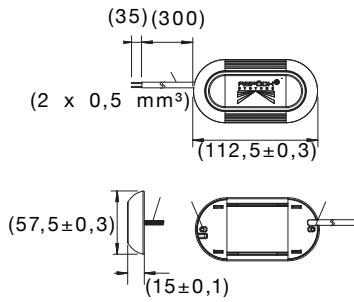

















































[C]



BEST. NR PART NO		BEST. NR AM PART NO AM			VERSION	ZUSATZ ADD ON	LUMEN	ANSCHLUSS CONNECTOR	KABEL CABLE
39-8900-157	1/-	39-8900-151	LED	12V 24V	[A]	IP 6K9K	300 lm	offenes Ende open end	0,30 m
39-8900-207	1/-	39-8900-201	LED	12V 24V	[A] mit Bewegungssensor with motion sensor	IP 67	300 lm	offenes Ende open end	0,30 m
39-8900-257	1/-	39-8900-251	LED	12V 24V	[A] mit Schalter with switch	IP 6K9K	300 lm	offenes Ende open end	0,30 m
39-8900-007	1/-	39-8900-001	LED	12V 24V	[B]	IP 6K9K	600 lm	offenes Ende open end	0,30 m
39-8900-057	1/-	39-8900-051	LED	12V 24V	[B] mit Bewegungssensor with motion sensor	IP 67	600 lm	offenes Ende open end	0,30 m
39-8900-107	1/-	39-8900-101	LED	12V 24V	[B] mit Schalter with switch	IP 6K9K	600 lm	offenes Ende open end	0,30 m
39-8900-307	1/-	39-8900-301	LED	12V 24V	[C]	IP 6K9K	500 lm	offenes Ende open end	0,30 m
39-8900-357	1/-	39-8900-351	LED	12V 24V	[C] mit Bewegungssensor with motion sensor	IP 67	500 lm	offenes Ende open end	0,30 m
39-8900-407	1/-	39-8900-401	LED	12V 24V	[C] mit Schalter with switch	IP 6K9K	500 lm	offenes Ende open end	0,30 m



PIKTOGRAMM ÜBERSICHT PICTOGRAM OVERVIEW

	Verpackungseinheit packaging unit		Seitenmarkierungslicht + Reflektor sidemarker + reflector
	x Stück pro Karton x pieces per box		Positionslicht hinten rear position light
	links left		positionslicht vorne front position light
	rechts right		rot, weiß, orange red, white, amber
	Leuchtmittel light source		rot, weiß red, white
	Volt		rot red
	Umrissarm end outline marker		weiß white
	Glühbirne bulb		Umrissleuchte end outline marker
	LED		Rückstrahler rot reflector red
	Fahrrichtungsanzeiger direction indicator		Rückstrahler gelb reflector amber
	Fahrrichtungsanzeiger rechts direction indicator right		Rückstrahler weiß reflector white
	Fahrrichtungsanzeiger links direction indicator left		Arbeitscheinwerfer working lamp
	dynamischer Fahrrichtungsanzeiger dynamic direction indicator		Kennzeichenbeleuchtung unten number plate lamp below
	dynamischer Fahrrichtungsanzeiger rechts dynamic direction indicator right		Kennzeichenbeleuchtung seitlich number plate lamp side
	dynamischer Fahrrichtungsanzeiger links dynamic direction indicator left		Rückfahralarm reverse alarm
	SMCG (Steuerung blinkender Seitenmarkierungsleuchten) SMCG (side marker control gear)		männlich male
	mit integriertem Blink-LCG with integrated direction indicator LCG		weiblich female
	mit integriertem LCG2 with integrated LCG2		Flood
	Rücklicht tail light		Spot
	Bremslicht stop light		horizontal Anbau horizontal mounting
	Nebelschlusslicht fog light		vertikal Anbau vertical mounting
	Rückfahrlicht reverse light		360° Anbau möglich 360° mounting possible
	Dreieckrückstrahler triangle reflector		... Lumen
	ohne Dreieckrückstrahler without triangle reflector		... Watt
	Positionslicht position light		ADR Zone 2
	Seitenmarkierungslicht sidemarker light		IP xx Schutzklasse IP xx rating
	Reflektor (Seitenmarkierungslicht) reflector (sidemarker light)		

product information_Inpoint_III_LED_V2 | 2024-07

Misprints, technical changes and illustrations are subject to change.

© Aspöck Systems GmbH

Non-compliance with the information given (e.g. temperature) results in the exclusion of warranty/liability. For details, see the mounting instructions/TSD www.aspoeck.com.