

# FLEXIPOINT II LED CLEAR LENS

LED UMRISSELEUCHTE

LED END OUTLINE MARKER



[aspoeck.com](http://aspoeck.com)



# PRODUCT INFO





## FLEXIPOINT II LED CLEAR LENS

LED UMRISSELEUCHTE

LED END OUTLINE MARKER

 POSITIONSLICHT VORNE  
FRONT POSITION LIGHT



 POSITIONSLICHT HINTEN  
REAR POSITION LIGHT



### FEATURES

**UMRISSELEUCHTE MIT LED TECHNOLOGIE**  
END OUTLINE MARKER WITH LED TECHNOLOGY

**MODERNES DESIGN**  
MODERN DESIGN

**KLARE LICHTSCHEIBE**  
CLEAR LENS

**VERFÜGBAR MIT GRAUEM ODER SCHWARZEM GEHÄUSE**  
AVAILABLE IN A GREY OR BLACK BASE

ADR  
Zone 2  IP6K9K





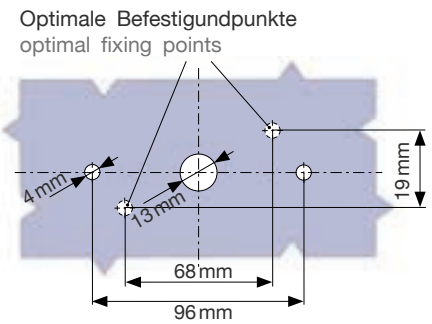
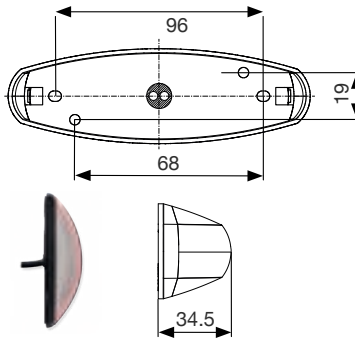
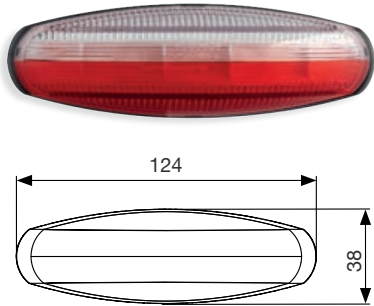

















































TECHNISCHE DATEN TECHNICAL FACTS			
LICHTSCHEIBENMATERIAL: LENS MATERIAL:		PC	
GEHÄUSEMATERIAL: HOUSING MATERIAL:		PC	
ARBEITSTEMPERATURBEREICH: OPERATING TEMPERATURE RANGE:		-40°C – +60°C	
HAUPTABMESSUNGEN: MAIN DIMENSIONS:		124 x 38 x 34.5 mm	
SPANNUNGSBEREICH: VOLTAGE RANGE:		10 – 30 V	
LEISTUNGS-AUFNAHME BEI NENN-SPANNUNG: POWER CONSUMPTION NOMINAL VOLTAGE:	STANDLICHT: PARKING LIGHT:	0.23 A / 2.7 W (12 V) 0.11 A / 2.7 W (24 V)	
EMV-ZULASSUNG: EMC-APPROVAL:	10R-5	E24	2025
TYPENGENEHMIGUNG: TYPE APPROVAL:	AM 02 RM1 02	E24	0151
BILDDIREKTIONAL: BIDIRECTIONAL:	JA YES		
SCHUTZART: PROTECTION CLASS:	IP69K (Leuchteinheit)		



BEST. NR PART NO	1/20	BEST. NR AM PART NO AM		12V 24V	FUNKTIONEN FUNCTIONS	ZUSATZ ADD ON	ANSCHLUSS CONNECTOR	KABEL CABLE
31-8524-007	1/20	31-8524-00!		12V 24V		Gehäuse schwarz black housing	offenes Ends open end	1,50 m
31-8524-017	1/20	31-8524-011		12V 24V		Gehäuse schwarz black housing	DC	2,50 m
31-8524-027	1/20	31-8524-021		12V 24V		Gehäuse grau grey housing	DC	2,50 m
31-8524-047	1/20	31-8524-041		12V 24V		Gehäuse grau + Rückstrahler grey housing + reflector	DC	5,00 m



## PIKTOGRAMM ÜBERSICHT PICTOGRAM OVERVIEW

	Verpackungseinheit packaging unit		Seitenmarkierungslicht + Reflektor sidemarker + reflector
	x Stück pro Karton x pieces per box		Positionslicht hinten rear position light
	links left		positionslicht vorne front position light
	rechts right		rot, weiß, orange red, white, amber
	Leuchtmittel light source		rot, weiß red, white
	Volt		rot red
	Umrissarm end outline marker		weiß white
	Glühbirne bulb		Umrissleuchte end outline marker
	LED		Rückstrahler rot reflector red
	Fahrtrichtungsanzeiger direction indicator		Rückstrahler gelb reflector amber
	Fahrtrichtungsanzeiger rechts direction indicator right		Rückstrahler weiß reflector white
	Fahrtrichtungsanzeiger links direction indicator left		Arbeitsscheinwerfer working lamp
	dynamischer Fahrtrichtungsanzeiger dynamic direction indicator		Kennzeichenbeleuchtung unten number plate lamp bottom
	dynamischer Fahrtrichtungsanzeiger rechts dynamic direction indicator right		Kennzeichenbeleuchtung seitlich number plate lamp side
	dynamischer Fahrtrichtungsanzeiger links dynamic direction indicator left		Rückfahralarm reverse alarm
	SMCG (Steuerung blinkender Seitenmarkierungsleuchten) SMCG (side marker control gear)		männlich male
	mit integriertem Blink-LCG with integrated direction indicator LCG		weiblich female
	mit integriertem LCG2 with integrated LCG2		Flood
	Rücklicht tail light		Spot
	Bremslicht stop light		horizontal Anbau horizontal mounting
	Nebelschlusslicht fog light		vertikal Anbau vertical mounting
	Rückfahrlicht reverse light		360° Anbau möglich 360° mounting possible
	Dreieckrückstrahler triangle reflector		... Lumen
	ohne Dreieckrückstrahler without triangle reflector		... Watt
	Positionslicht position light		ADR Zone 2
	Seitenmarkierungslicht sidemarker light		IP xx Schutzklasse IP xx rating
	Reflektor (Seitenmarkierungslicht) reflector (sidemarker light)		

product information\_Flexipoint\_II\_LED\_clear\_lens\_V2 | 2024-07  
Misprints, technical changes and illustrations are subject to change.  
© Aspöck Systems GmbH

Non-compliance with the information given (e.g. temperature) results in the exclusion of warranty/liability. For details, see the mounting instructions/TSD [www.aspoeck.com](http://www.aspoeck.com).