

FLEXLED PROFILES

FÜR DIE MONTAGE VON FLEXLED
MEDIUM BÄNDERN

FOR THE MOUNTING OF FLEXLED
MEDIUM STRIPS



aspoeck.com



PRODUCT INFO

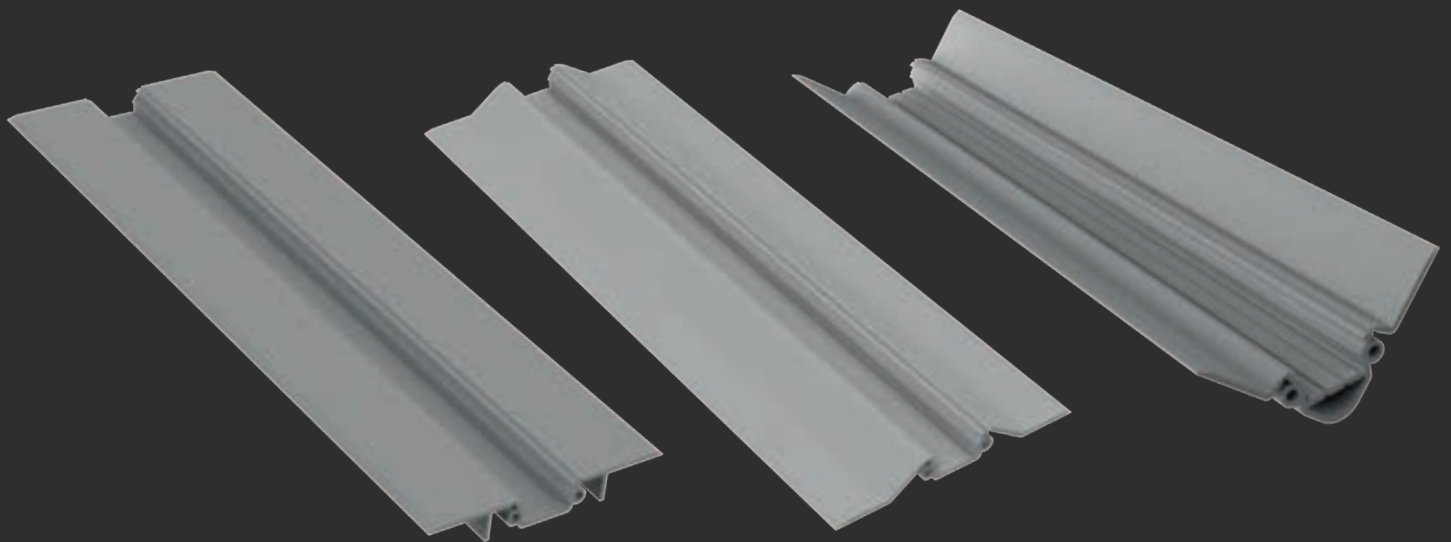



FLEXLED - PROFILES

FÜR DIE PROFESSIONELLE MONTAGE VON FLEXLED MEDIUM BÄNDERN
FOR A PROFESSIONAL MOUNTING OF FLEXLED MEDIUM STRIPS

FLAT

RAMP

CORNER 45°

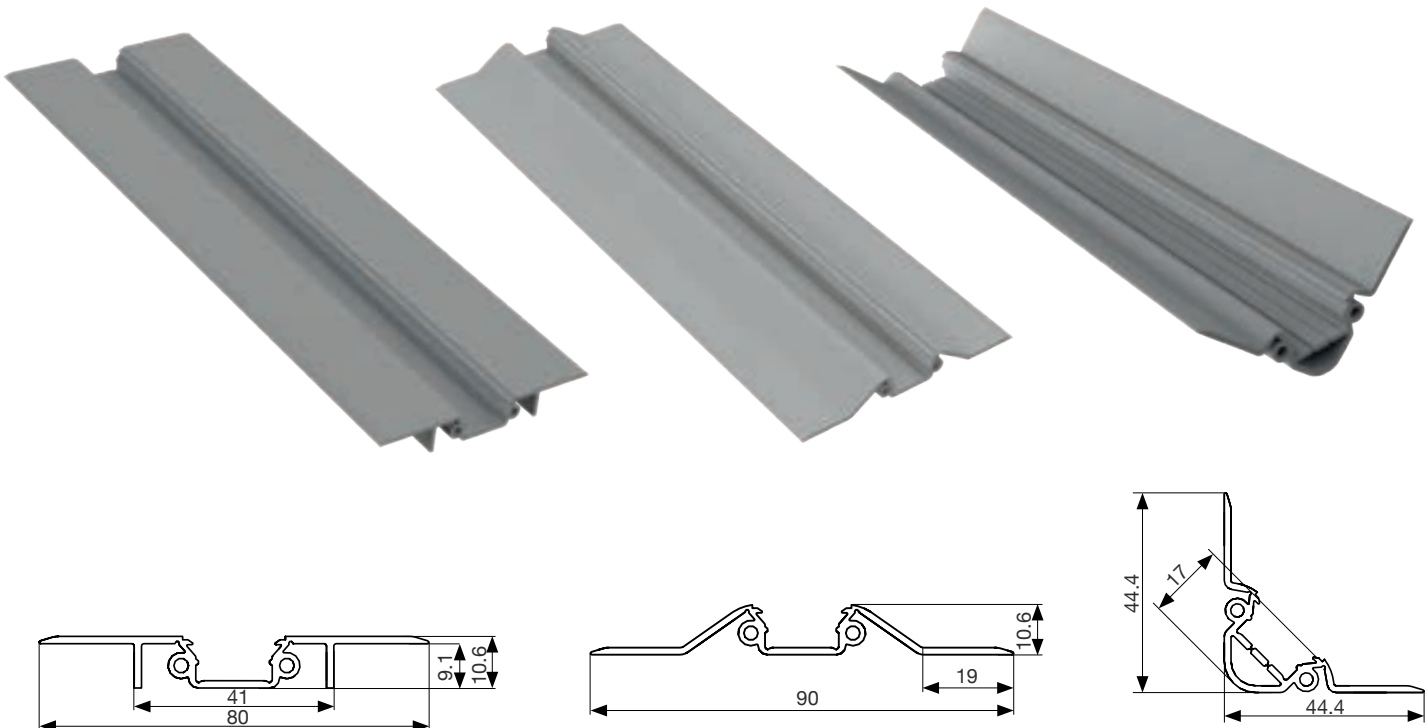

FEATURES

EINFACHE MONTAGE
EASY MOUNTING

IM INNEN- & AUSSENBEREICH ANWENDBAR
CAN BE USED INDOORS & OUTDOORS







PROFILE IN SCHWARZ UND LICHTGRAU ERHÄLTlich FÜR EINEN UNAUFFÄLLIGEN ANBAU
PROFILES AVAILABLE IN BLACK AND LIGHT GREY FOR INCONSPICUOUS INSTALLATION

FLÄCHENBÜNDIGER EINBAU MÖGLICH (BEI FLAT PROFIL)
FLUSH MOUNTING POSSIBLE (FOR PLAT PROFILE)

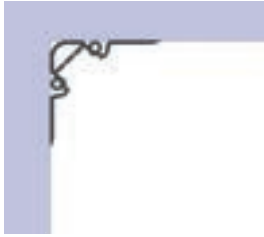
MIT VORSPANNUNG EXTRUDIERT, UM SICH PERFEKT INS ECK EINZUFÜGEN (BEI CORNER PROFIL)
EXTRUDED WITH PRELOAD TO FIT PERFECTLY INTO THE CORNER (FOR CORNER PROFILE)

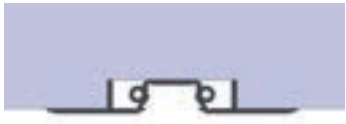



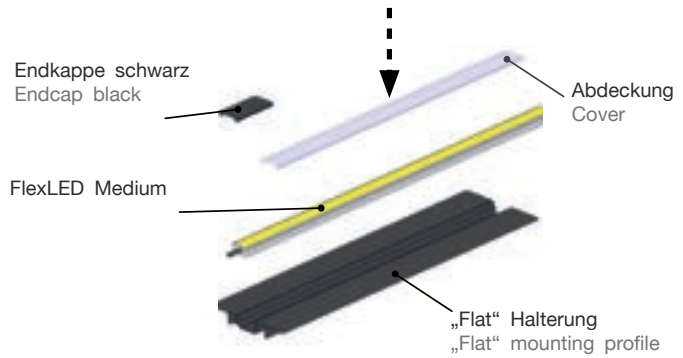

TECHNISCHE DATEN TECHNICAL FACTS	
VIBRATIONSGEPRÜFT: VIBRATION TESTED:	Aspöck Systems Vibrationstest (PAW 80.04) Aspöck Systems vibration test (PAW 80.04)
UV-STABILITÄT: UV STABILITY:	2000 Stunden 2000 hours
MATERIAL: MATERIAL:	PVC
ARBEITSTEMPERATURBEREICH: WORKING TEMPERATURE RANGE:	-20°C - +50°C
LAGERTEMPERATURBEREICH: STORAGE TEMPERATURE RANGE:	-40°C - +80°C
CHEMISCHE BESTÄNDIGKEIT: CHEMICAL RESISTANCE:	Diesel, bleifreies Benzin, Isopropylalkohol-Reiniger, Motoröl, Auto-/Lkw-Waschchemikalien Diesel, unleaded gasoline, isopropyl alcohol cleaner, motor oil, car/truck wash chemicals

ANWENDUNGSBEISPIELE APPLICATION EXAMPLES			
CORNER 45°			
FLAT			
RAMP			

PRODUCT INFO



BESCHREIBUNG DESCRIPTION	OEM
 <p>Mounting Profile - Medium Cover 1,0 m In Kombination mit IP66 oder nicht vergossenen Bändern notwendig Necessary in combination with IP66 or non-encapsulated strips</p> <p>transparent diffuse</p>	<p>15-5250-737 15-5250-747</p>
 <p>Mounting Profile - Medium Endcap 1,0 m Zur Abdeckung von Blindbereichen / For covering blind areas</p> <p>grey RAL 7035 black RAL 9005</p>	<p>15-5250-757 15-5250-767</p>
 <p>Mounting Profile - Medium Ramp 1,0 m</p> <p>grey RAL 7035 black RAL 9005</p>	<p>14-4230-657 14-4230-627</p>
 <p>Mounting Profile - Medium Flat 1,0 m</p> <p>grey RAL 7035 black RAL 9005</p>	<p>14-4230-667 14-4230-637</p>
 <p>Mounting Profile - Medium Corner 45° 1,0 m</p> <p>grey RAL 7035 black RAL 9005</p>	<p>14-4230-677 14-4130-647</p>

Sonderlängen auf Anfrage.
Special lengths on request.

product information_FlexLED_Profiles_V2 | 2024-07
Misprints, technical changes and illustrations are subject to change.
© Aspöck Systems GmbH

Non-compliance with the information given (e.g. temperature) results in the exclusion of warranty/liability. For details, see the mounting instructions/TSD www.aspoeck.com.