

FLASHLED

LICHTSIGNAL/BLITZLICHT IM
EINZIGARTIGEM DESIGN

BEACON IN UNIQUE DESIGN



aspoeck.com



PRODUCT INFO





FLASHLED

HOCHWERTIGES LICHTSIGNAL/BLITZLICHT MIT EINZIGARTIGEM DESIGN
HIGH QUALITY BEACON WITH UNIQUE DESIGN



FEATURES

CISPR25 KLASSE 3 + 5
CISPR25 CLASS 3 + 5

ADR Zone 2  IP 6K9K





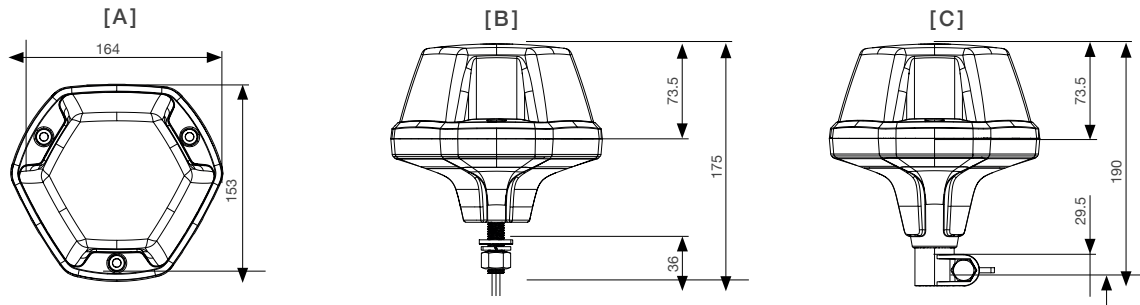

FÜR ANSPRUCHSVOLLE ANWENDUNGEN BEI SELBSTFAHRENDEN ARBEITSMASCHINEN
FOR DEMANDING APPLICATIONS IN SELF-PROPELLED MACHINES

DREI VERSCHIEDENE BLITZMUSTER
THREE DIFFERENT FLASH-PATTERNS

VERSCHIEDENE HALTERUNGEN (DIREKTMONTAGE, EINZELSCHRAUBENHALTERUNG, DIN-HALTER)
DIFFERENT BRACKETS (DIRECT MOUNTING, SINGLE MOUNTING, DIN BRACKET)

MULTI-SPANNUNG
MULTI-VOLTAGE



























































BEST. NR OEM PART NO OEM	BEST. NR AM PART NO AM				VERSION	ZUSATZ ADD ON	ANSCHLUSS CONNECTOR	KABEL CABLE
39-9024-037	39-9024-031	1/24		12V 24V	[A]	Einzelblitz/Doppelblitz/Rotation, Direktmontage, ECE + SAE single flash/double flash, rotation direct assembling, ECE + SAE	offenes Ende open end	0,30 m
39-9024-017	39-9024-011	1/24		12V 24V	[B]	Einzelblitz/Doppelblitz/Rotation, Einzelschraubhalterung, ECE + SAE single flash/double flash/rotation, single bolt, ECE + SAE	offenes Ende open end	0,30 m
29-9024-037	29-9034-031	1/24		12V 24V	[C]	Doppelblitz, DIN Halter, ECE + SAE double flash, DIN bracket, ECE + SAE	DIN	

TECHNISCHE DATEN TECHNICAL FACTS		EINZELBLITZ SINGLE FLASH	DOPPELBLITZ DOUBLE FLASH	ROTATION ROTATION
SPANNUNGSBEREICH/LEISTUNGS-AUFNAHME: VOLTAGE RANGE/ POWER CONSUMPTION:		10 V - 30 V / 24 W		
NENNSPANNUNG: NOMINAL VOLTAGE:		12V/24 V		
LICHTSCHEIBENFARBE: LENS COLOUR:		amber		
VERPOLSCHUTZ: REVERSE POLARITY PROTECTION:		JA YES		
MATERIAL: MATERIAL:	GEHÄUSE: HOUSING:	PBT		
	LICHTSCHEIBE: LENS:	PC		
TEMPERATURBEREICH: TEMPERATURE RANGE:		-40°C - +85°C		
LAGERTEMPERATUR: STORAGE TEMPERATURE:		-40°C - +105°C		
GEWICHT DER LEUCHTE (OHNE HALTERUNG): WEIGHT OF LAMP (WITHOUT BRACKET):		416g ±5%		
SCHUTZART DER LEUCHTE: PROTECTION CLASSIFICATION OF THE LAMP:		IP 6K9K		
EMV-ZULASSUNG: EMC APPROVAL:		10R 06 E24 3220		
		CIRSPR 25		
		Klasse 3	Klasse 5	Klasse 3
TYPGENEHMIGUNG (ECE R65): TYPE APPROVAL (ECE R65):		TA1 E9 00.6521		
TYPGENEHMIGUNG (SAE): TYPE APPROVAL (SAE):		SAE W3-1 21		
BIDIREKTIONAL: BIDIRECTIONAL:		NEIN NO		
ADR-TEST (NUR LICHTMODUL): ADR TEST (LIGHT MODULE ONLY):		ADR Zone 2		
RoHS - RICHTLINIE: RoHS - DIRECTIVE:		JA YES		
REACH - SVHC ZERTIFIZIERT: REACH - SVHC CERTIFIED:		JA YES		



TECHNISCHE DATEN TECHNICAL FACTS		EINZELBLITZ SINGLE FLASH	DOPPELBLITZ DOUBLE FLASH	ROTATION ROTATION
EINZELSCHRAUBEN- HALTERUNG: SINGLE BOLT:	HALTERINGMATERIAL: RETAINING RING MATERIAL:	PC + ABS		
	HALTERMATERIAL: RETAINING MATERIAL:	EPDM		
	GEWICHT DES SOCKELS: WEIGHT OF THE BASE:	290g ±5%		
DIN HALTER: DIN BRACKET:	HALTERINGMATERIAL: RETAINING RING MATERIAL:	-	PC + ABS	-
	HALTERMATERIAL: RETAINING MATERIAL:	-	EPDM	-
	GEWICHT DES SOCKELS: WEIGHT OF THE BASE:	-	312g ±5%	-
LICHTFUNKTIONEN: LIGHT FUNCTIONS:				
29-9024-XXX	ANSCHLÜSSE UND BELEGUNG: CONNECTIONS AND ASSIGNMENT:	-		-
39-9024-XXX	UMSCHALTBARE LICHTFUNKTIONEN: SWITCHABLE LIGHT FUNCTIONS:		<p>Um die Lichtfunktionen wechseln zu können, muss für eine Zeit von einer Sekunde eine „+“ Spannung am blauen Draht angelgt werden. Auslieferungszustand = Doppelblitz To be able to change the light functions, a „+“ voltage must be applied to the blue wire for a period of one second. Delivery state = double flash</p>	



PIKTOGRAMM ÜBERSICHT PICTOGRAM OVERVIEW			
	Verpackungseinheit packaging unit		Positionslicht hinten rear position light
	x Stück pro Karton x pieces per box		positionslicht vorne front position light
	links left		rot, weiß, orange red, white, amber
	rechts right		rot, weiß red, white
	Leuchtmittel light source		rot red
	Volt		weiß white
	Umrissarm end outline marker		Umrissleuchte end outline marker
	Glühbirne bulb		Rückstrahler rot reflector red
	LED		Rückstrahler gelb reflector amber
	Fahrtrichtungsanzeiger direction indicator		Rückstrahler weiß reflector white
	Fahrtrichtungsanzeiger rechts direction indicator right		Arbeitsscheinwerfer working lamp
	Fahrtrichtungsanzeiger links direction indicator left		Kennzeichenbeleuchtung unten number plate lamp bottom
	dynamischer Fahrtrichtungsanzeiger dynamic direction indicator		Kennzeichenbeleuchtung seitlich number plate lamp side
	dynamischer Fahrtrichtungsanzeiger rechts dynamic direction indicator right		Rückfahralarm reverse alarm
	dynamischer Fahrtrichtungsanzeiger links dynamic direction indicator left		männlich male
	SMCG (Steuerung blinkender Seitenmarkierungsleuchten) SMCG (side marker control gear)		weiblich female
	mit integriertem Blink-LCG with integrated direction indicator LCG		Flood
	mit integriertem LCG2 with integrated LCG2		Spot
	Rücklicht tail light		horizontal Anbau horizontal mounting
	Bremslicht stop light		vertikal Anbau vertical mounting
	Nebelschlusslicht fog light		360° Anbau möglich 360° mounting possible
	Rückfahrlicht reverse light		... Lumen
	Dreieckrückstrahler triangle reflector		... Watt
	ohne Dreieckrückstrahler without triangle reflector		ADR Zone 2
	Positionslicht position light		IP xx Schutzklasse IP xx rating
	Seitenmarkierungslicht sidemarker light		Spannungsversorgung power supply
	Reflektor (Seitenmarkierungslicht) reflector (sidemarker light)		Masse mass
	Seitenmarkierungslicht + Reflektor sidemarker + reflector		Umschaltbare Lichtfunktionen switchable light functions