

AGRIPOINT

SCHLUSS-BREMS-BLINKLEUCHE

TAIL, STOP AND
DIRECTION INDICATOR



aspoeck.com



PRODUCT INFO





AGRIPOINT

SCHLUSS-BREMS-BLINKLEUCHTE
TAIL, STOP AND DIRECTION INDICATOR

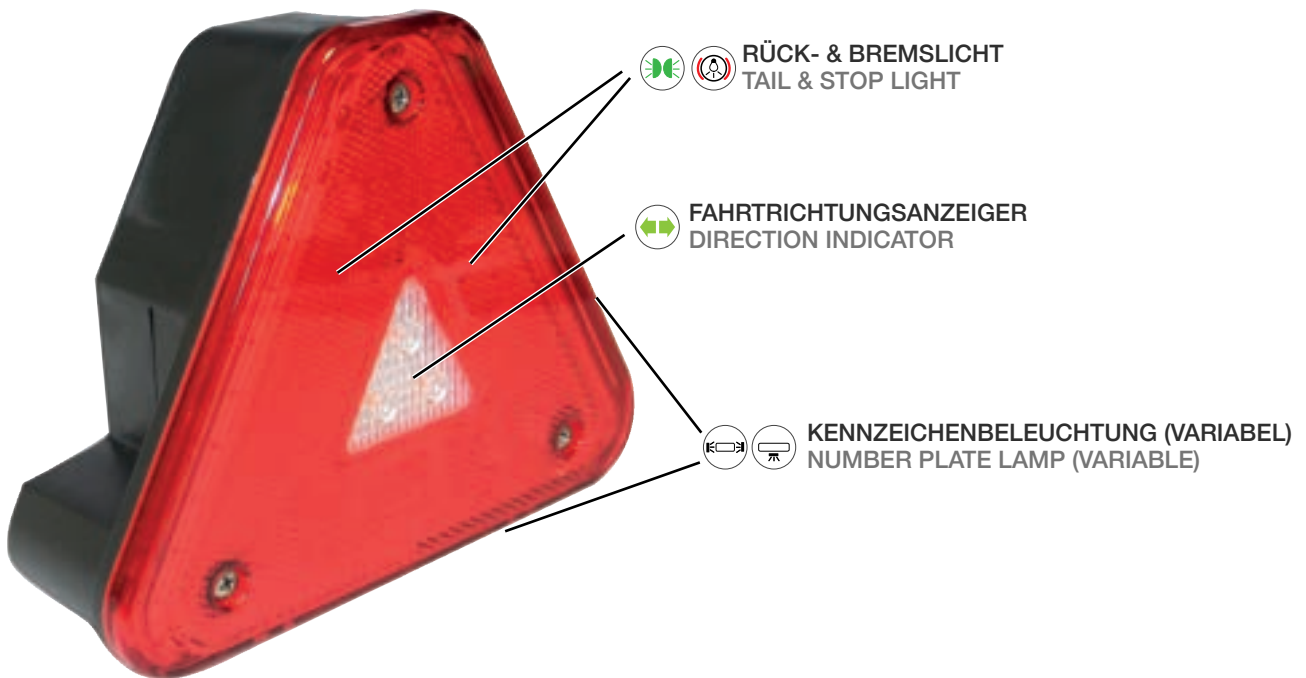

FEATURES

ADR Zone 2 IP 6K9K

KOMPAKTE 3-KAMMER-LEUCHTE
COMPACT 3-CHAMBER LAMP

VOLL LED ODER GLÜHBIRNE + LED KOMBIENIERT
FULL LED OR BULB + LED COMBINED

UNTERSCHIEDLICHE VARIANTEN (ANSCHLUSS, KABEL)
DIFFERENT VARIANTS (CONNECTION, CABLE)

KENNZEICHENBELEUCHTUNG VARIABEL
VARIABLE NUMBER PLATE LIGHT



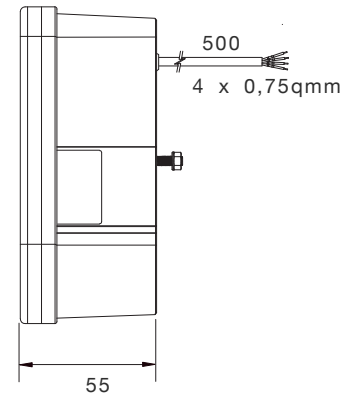
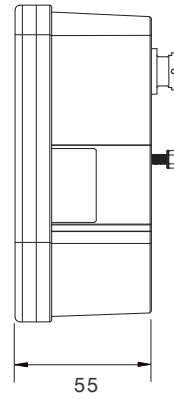
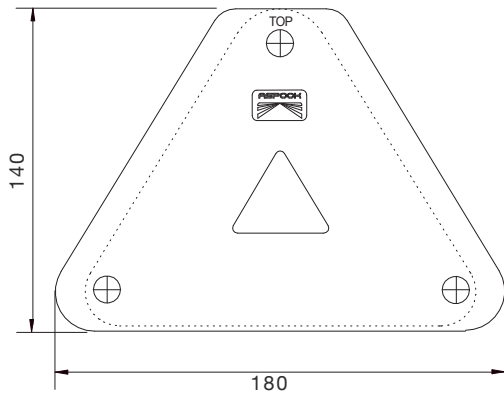

















































PRODUCT INFO



BEST. NR PART NO	1/20	BEST. NR AM PART NO AM	←	→			FUNKTIONEN FUNCTIONS	ZUSATZ ADD ON	ANSCHLUSS CONNECTOR	KABEL CABLE
23-4004-537	1/20	23-4004-531	●	●		12V			5 pol. Bajonett 5 pin Bayonet	♂
23-4004-507	1/20	23-4004-501	●	●		12V			5 pol. Bajonett 5 pin Bayonet	♂
23-4004-007	1/20	23-4004-001	●	●		12V			offenes Ende open end	0,50 m
23-4004-037	1/20	23-4004-031	●	●		12V			offenes Ende open end	0,50 m
23-4000-507	1/20	23-4000-501	●	●		12V			5 pol. Bajonett 5 pin Bayonet	♂
23-4000-537	1/20	23-4000-531	●	●		12V			5 pol. Bajonett 5 pin Bayonet	♂
23-4000-007	1/20	23-4000-001	●	●		12V			offenes Ende open end	0,50 m
23-4000-037	1/20	23-4000-031	●	●		12V			offenes Ende open end	0,50 m



PIKTOGRAMM ÜBERSICHT PICTOGRAM OVERVIEW

	Verpackungseinheit packaging unit		Seitenmarkierungslicht + Reflektor sidemarker + reflector
	x Stück pro Karton x pieces per box		Positionslicht hinten rear position light
	links left		positionslicht vorne front position light
	rechts right		rot, weiß, orange red, white, amber
	Leuchtmittel light source		rot, weiß red, white
	Volt		rot red
	Umrisssarm end outline marker		weiß white
	Glühbirne bulb		Umrisssleuchte end outline marker
	LED		Rückstrahler rot reflector red
	Fahrtrichtungsanzeiger direction indicator		Rückstrahler gelb reflector amber
	Fahrtrichtungsanzeiger rechts direction indicator right		Rückstrahler weiß reflector white
	Fahrtrichtungsanzeiger links direction indicator left		Arbeitsscheinwerfer working lamp
	dynamischer Fahrtrichtungsanzeiger dynamic direction indicator		Kennzeichenbeleuchtung number plate lamp
	dynamischer Fahrtrichtungsanzeiger rechts dynamic direction indicator right		Rückfahralarm reverse alarm
	dynamischer Fahrtrichtungsanzeiger links dynamic direction indicator left		männlich male
	SMCG (Steuerung blinkender Seitenmarkierungsleuchten) SMCG (side marker control gear)		weiblich female
	mit integriertem Blink-LCG with integrated direction indicator LCG		Flood
	mit integriertem LCG2 with integrated LCG2		Spot
	Rücklicht tail light		horizontal Anbau horizontal mounting
	Bremslicht stop light		vertikal Anbau vertical mounting
	Nebelschlusslicht fog light		360° Anbau möglich 360° mounting possible
	Rückfahrlicht reverse light		... Lumen
	Dreieckrückstrahler triangle reflector		... Watt
	ohne Dreieckrückstrahler without triangle reflector		ADR Zone 2
	Positionslicht position light		IP xx Schutzklasse IP xx rating
	Seitenmarkierungslicht sidemarker light		
	Reflektor (Seitenmarkierungslicht) reflector (sidemarker light)		